NI-9375

Specifications

2022-11-28



Contents

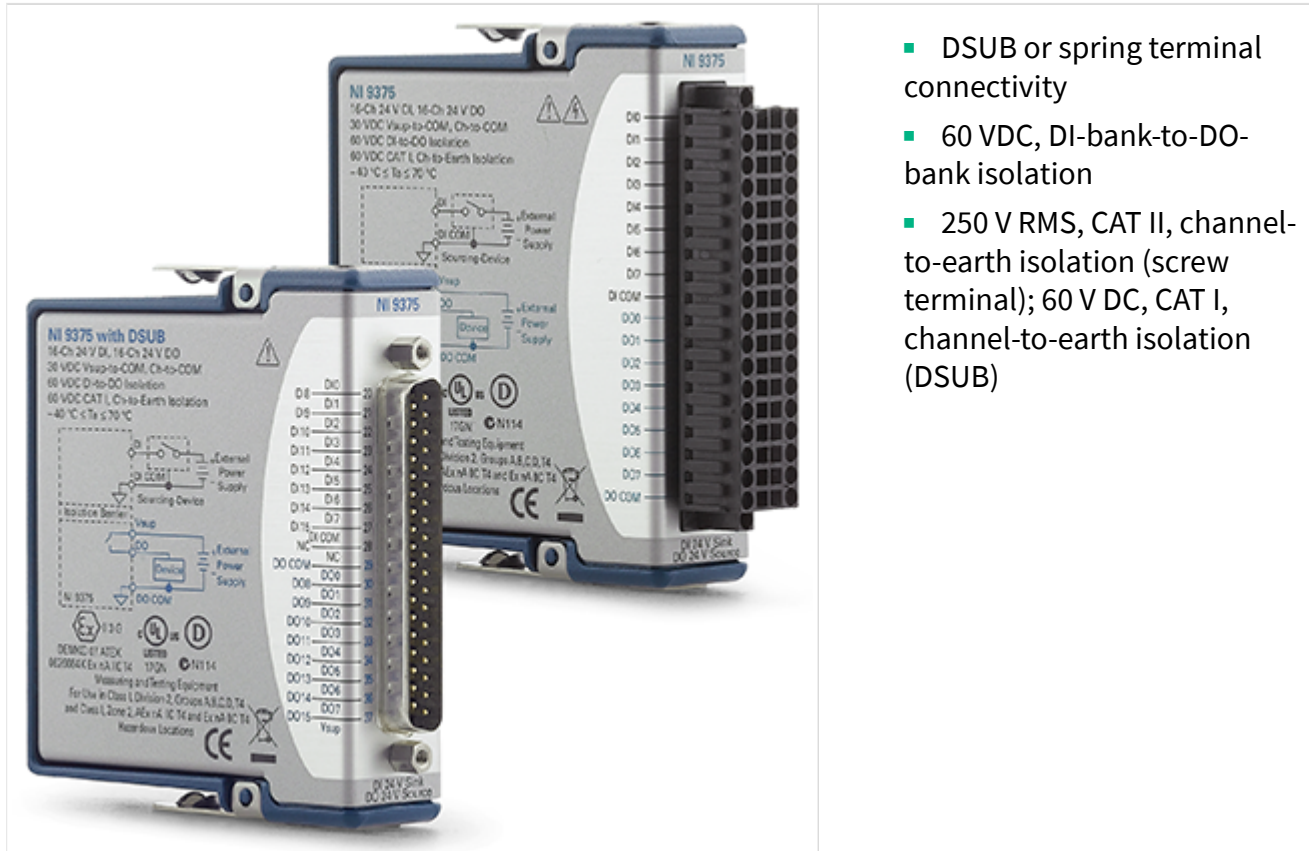

NI 9375 Datasheet.....	3
NI 9375 Specifications.....	8

NI 9375 Datasheet



- DSUB or spring terminal connectivity
- 60 VDC, DI-bank-to-DO-bank isolation
- 250 V RMS, CAT II, channel-to-earth isolation (screw terminal); 60 V DC, CAT I, channel-to-earth isolation (DSUB)

The NI 9375 is a combination digital input, digital output module for CompactDAQ and CompactRIO systems. The digital input lines are compatible with 24 V logic levels and the digital output lines are compatible with 6 V to 30 V signals, based on the external power supply. The NI 9375 offers 1,000 Vrms withstand isolation from channel to earth ground. It works with industrial logic levels and signals for direct connection to a wide array of industrial switches, transducers, and other devices.

 <p>Kit Contents</p>	<ul style="list-style-type: none"> • NI 9375 • NI 9375 Getting Started Guide • Flathead Screwdriver (Spring Terminal)
 <p>Accessories</p>	<ul style="list-style-type: none"> • NI 9940 Backshell Connector Kit (Spring Terminal) • NI 9923 Screw-Terminal Block (DSUB)

C SERIES DIGITAL MODULE COMPARISON					
Product Name	Signal Levels	Channels	Direction	Update Rate	Connectivity
NI 9375	12 V, 24 V	8 DI, 8 DO	Sinking Input, Sourcing Output	7 μ s (DI), 500 μ s (DO)	Spring-Terminal, DSUB
NI 9421	12 V to 24 V	8 DI	Sinking Input	100 μ s	Screw-Terminal, Spring-Terminal, DSUB
NI 9425	12 V, 24 V	32 DI	Sinking Input	7 μ s	DSUB
NI 9472	6 V to 30 V	8 DO	Sourcing Output	100 μ s	Screw-Terminal, Spring-Terminal
NI 9476	6 V to 30 V	32 DO	Sourcing Output	500 μ s	DSUB

NI C Series Overview



NI provides more than 100 C Series modules for measurement, control, and communication applications. C Series modules can connect to any sensor or bus and allow for high-accuracy measurements that meet the demands of advanced data acquisition and control applications.

- Measurement-specific signal conditioning that connects to an array of sensors and signals

- Isolation options such as bank-to-bank, channel-to-channel, and channel-to-earth ground
- -40 °C to 70 °C temperature range to meet a variety of application and environmental needs
- Hot-swappable

The majority of C Series modules are supported in both CompactRIO and CompactDAQ platforms and you can move modules from one platform to the other with no modification.

CompactRIO



CompactRIO combines an open-embedded architecture with small size, extreme ruggedness, and C Series modules in a platform powered by the NI LabVIEW reconfigurable I/O (RIO) architecture. Each system contains an FPGA for custom timing, triggering, and processing with a wide array of available modular I/O to meet any embedded application requirement.

CompactDAQ

CompactDAQ is a portable, rugged data acquisition platform that integrates connectivity, data acquisition, and signal conditioning into modular I/O for directly interfacing to any sensor or signal. Using CompactDAQ with LabVIEW, you can easily customize how you acquire, analyze, visualize, and manage your measurement data.



Software

LabVIEW Professional Development System for Windows



- Use advanced software tools for large project development
- Generate code automatically using DAQ Assistant and Instrument I/O Assistant
- Use advanced measurement analysis and digital signal processing
- Take advantage of open connectivity with DLLs, ActiveX, and .NET objects
- Build DLLs, executables, and MSI installers

NI LabVIEW FPGA Module

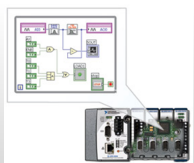

- Design FPGA applications for NI RIO hardware
- Program with the same graphical environment used for desktop and real-time applications
- Execute control algorithms with loop rates up to 300 MHz
- Implement custom timing and triggering logic, digital protocols, and DSP algorithms
- Incorporate existing HDL code and third-party IP including Xilinx IP generator functions
- Purchase as part of the LabVIEW Embedded Control and Monitoring Suite

NI LabVIEW Real-Time Module

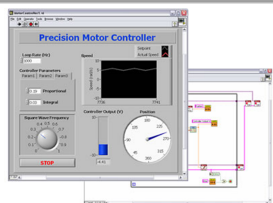

- Design deterministic real-time applications with LabVIEW graphical programming
- Download to dedicated NI or third-party hardware for reliable execution and a wide selection of I/O
- Take advantage of built-in PID control, signal processing, and analysis functions
- Automatically take advantage of multicore CPUs or set processor affinity manually
- Take advantage of real-time OS, development and debugging support, and board support

NI LabVIEW Real-Time Module

- Purchase individually or as part of a LabVIEW suite

NI 9375 Circuitry

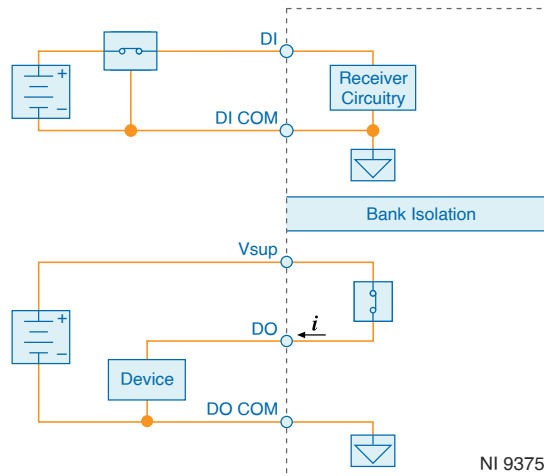

- The bank of 16 digital input channels and the bank of 16 digital output channels on the NI 9375 are isolated from each other and isolated from earth ground.
- The NI 9375 internally limits current signals connected to DI.
- The NI 9375 has sinking inputs. Sinking inputs provide a path to COM when the sourcing device connected to the NI 9375 drives current or applies voltage to DI.
- The NI 9375 has sourcing outputs. Sourcing outputs drive current from V_{sup} to DO when the channel is on.



Tip For more information about sinking inputs and sourcing outputs, visit ni.com/r/sinksource.

Allowable Current Per Module

The NI 9375 has a per module continuous output current specification. Use the following equation to determine whether the total module current of your loads for channels that are turned on are within the specification.

Figure 1. Total Module Current Equation

$$(I_{DO0})^2 + (I_{DO1})^2 + \dots + (I_{DO15})^2 = \text{Total Module Current}$$

$$(I_{DO0})^2 + (I_{DO1})^2 + \dots + (I_{DO15})^2 = \text{Total Module Current}$$

For example, an NI 9375 with spring terminal with two channels at 250 mA, six channels at 125 mA, and eight channels at 62 mA has the following per module continuous output current.

Figure 2. Total Module Current Example

$$\left\{ \left[(250 \text{ mA})^2 * 2 \right] + \left[(125 \text{ mA})^2 * 6 \right] + \left[(62 \text{ mA})^2 * 8 \right] \right\} = 0.25 \text{ A}^2$$

$$\left\{ \left[(250 \text{ mA})^2 * 2 \right] + \left[(125 \text{ mA})^2 * 6 \right] + \left[(62 \text{ mA})^2 * 8 \right] \right\} = 0.25 \text{ A}^2$$

NI 9375 Specifications

The following specifications are typical for the range -40 °C to 70 °C unless otherwise noted. All voltages are relative to COM unless otherwise noted.



Caution Do not operate the NI 9375 in a manner not specified in this document. Product misuse can result in a hazard. You can compromise the safety protection built into the product if the product is damaged in any way. If the product is damaged, return it to NI for repair.

Input/Output Characteristics

Number of channels	32 channels: 16 digital input and 16 digital output
--------------------	---

Digital Input

Input type	Sinking	
Input voltage range	0 VDC to 30 VDC	
Digital logic levels		
OFF state		
Input voltage	≤5 V	
Input current	≤150 μA	
ON state		
Input voltage	≥10 V	
Input current	≥330 μA	
Hysteresis		
Input voltage	1.7 V minimum	
Input current	50 μA minimum	
Input impedance	30 kΩ ±5%	
Setup time ^[1]	1 μs maximum	
Update/transfer time ^[2]	7 μs maximum	

Digital Output

Output type	Sourcing	
Power-on output state	Channels off	
External power supply voltage range (V _{sup})	6 VDC to 30 VDC	
Continuous output current (I_O)		
NI 9375 with spring terminal		

All channels on	125 mA maximum (per channel)
One channel on	500 mA maximum
Per module	0.25 A ²
NI 9375 with DSUB	
All channels on	100 mA maximum (per channel)
One channel on	400 mA maximum
Per module	0.16 A ² maximum
Output impedance (R_O)	0.3 Ω maximum
Output voltage (V_O)	V _{sup} - (I_OR_O)
Reversed-voltage protection	None
Current limiting	None
V _{sup} current consumption	18 mA
Update/transfer time ^[3]	7 μs maximum
Propagation delay ^[4]	500 μs maximum

Related reference

- [Allowable Current Per Module](#)

Power Requirements

Power consumption from chassis	
Active mode	450 mW maximum
Sleep mode	25 μW maximum
Thermal dissipation (at 70 °C)	
Active mode	1.5 W maximum

Sleep mode	0.6 W maximum
------------	---------------

Physical Characteristics

Spring-terminal wiring

Gauge	0.08 mm ² to 1.0 mm ² (28 AWG to 18 AWG) copper conductor wire
Wire strip length	7 mm (0.28 in.) of insulation stripped from the end
Temperature rating	90 °C, minimum
Wires per spring terminal	One wire per spring terminal

Connector securement

Securement type	Screw flanges provided
Torque for screw flanges	0.2 N · m (1.80 lb · in.)

Weight

NI 9375 with spring terminal	159 g (5.6 oz)
NI 9375 with DSUB	148 g (5.3 oz)

NI 9375 with Spring Terminal (Black Connector) Safety Voltages

Connect only voltages that are within the following limits.

Channel-to-COM or Vsup-to-COM	30 V DC maximum
-------------------------------	-----------------

Isolation

DI bank-to-DO bank	60 V DC maximum
Channel-to-Channel	No isolation between channels

Channel-to-earth ground

Continuous	60 V DC, Measurement Category I
------------	---------------------------------

Withstand	1,000 V RMS, verified by a 5 s dielectric withstand test
-----------	--

Hazardous Locations

U.S. (UL)	Class I, Division 2, Groups A, B, C, D, T4; Class I, Zone 2, AEx nA IIC T4 Gc
Canada (C-UL)	Class I, Division 2, Groups A, B, C, D, T4; Ex nA IIC T4 Gc
Europe (ATEX) and International (IECEX)	Ex nA IIC T4 Gc DEMKO 07 ATEX 0626664X IECEX UL 14.0089X

Safety Compliance and Hazardous Locations Standards

This product is designed to meet the requirements of the following electrical equipment safety standards for measurement, control, and laboratory use:

- IEC 61010-1, EN 61010-1
- UL 61010-1, CSA C22.2 No. 61010-1
- EN 60079-0, EN 60079-7
- IEC 60079-0, IEC 60079-7
- UL 60079-0, UL 60079-7
- CSA C22.2 No. 60079-0, CSA C22.2 No. 60079-7



Note For safety certifications, refer to the product label or the [Product Certifications and Declarations](#) section.

Electromagnetic Compatibility

This product meets the requirements of the following EMC standards for electrical equipment for measurement, control, and laboratory use:

- EN 61326-1 (IEC 61326-1): Class A emissions; Industrial immunity
- EN 55011 (CISPR 11): Group 1, Class A emissions

- AS/NZS CISPR 11: Group 1, Class A emissions
- FCC 47 CFR Part 15B: Class A emissions
- ICES-001: Class A emissions



Note For EMC declarations and certifications, refer to the [Online Product Certification](#) section.

CE Compliance

- 2014/34/EU; Potentially Explosive Atmospheres (ATEX)

Product Certifications and Declarations

Refer to the product Declaration of Conformity (DoC) for additional regulatory compliance information. To obtain product certifications and the DoC for NI products, visit ni.com/product-certifications, search by model number, and click the appropriate link.

Shock and Vibration

To meet these specifications, you must panel mount the system.

Operating vibration	
Random	5 g RMS, 10 Hz to 500 Hz
Sinusoidal	5 g, 10 Hz to 500 Hz
Operating shock	30 g, 11 ms half sine; 50 g, 3 ms half sine; 18 shocks at 6 orientations

Environmental

Refer to the manual for the chassis you are using for more information about meeting these specifications.

Operating temperature (IEC 60068-2-1, IEC 60068-2-2)	-40 °C to 70 °C
--	-----------------

Storage temperature (IEC 60068-2-1, IEC 60068-2-2)	-40 °C to 85 °C
Ingress protection	IP40
Operating humidity (IEC 60068-2-30)	10% RH to 90% RH, noncondensing
Storage humidity (IEC 60068-2-30)	5% RH to 95% RH, noncondensing
Pollution Degree	2
Maximum altitude	2,000 m

Indoor use only.

Environmental Management

NI is committed to designing and manufacturing products in an environmentally responsible manner. NI recognizes that eliminating certain hazardous substances from our products is beneficial to the environment and to NI customers.

For additional environmental information, refer to the **Engineering a Healthy Planet** web page at ni.com/environment. This page contains the environmental regulations and directives with which NI complies, as well as other environmental information not included in this document.

EU and UK Customers

-  **Waste Electrical and Electronic Equipment (WEEE)**—At the end of the product life cycle, all NI products must be disposed of according to local laws and regulations. For more information about how to recycle NI products in your region, visit ni.com/environment/weee.

电子信息产品污染控制管理办法（中国 RoHS）

-  **中国 RoHS**—NI 符合中国电子信息产品中限制使用某些有害物质指令(RoHS)。关于 NI 中国 RoHS 合规性信息，请登录 ni.com/environment/rohs_china。(For information about China RoHS compliance, go to ni.com/environment/rohs_china.)

¹ **Setup time** is the amount of time input signals must be stable before reading from the module.

² **Update/transfer time** is the maximum time the software takes to read data from the module. The update/transfer is valid when the module is used in a CompactRIO system. When used in other systems, driver software and system latencies impact this time.

³ **Update/transfer time** is the maximum time the software takes to write data to the module. The update/transfer is valid when the module is used in a CompactRIO system. When used in other systems, driver software and system latencies impact this time.

⁴ **Propagation delay** is the amount of time it takes the output signals to change state after being written to.